

# **Installing the A4979A PMC Graphics Card**



**HP Part No. A4979-90602  
Edition E1098  
Printed in U.S.A.**

© Hewlett-Packard Co. 1998

### Printing History

First Printing: July 1998

Latest Printing: October 1998

UNIX is a registered trademark of The Open Group.

### NOTICE

The information contained in this document is subject to change without notice.

HEWLETT-PACKARD MAKES NO WARRANTY OF ANY KIND WITH REGARD TO THIS MATERIAL INCLUDING BUT NOT LIMITED TO THE IMPLIED WARRANTIES OF MERCHANTABILITY AND FITNESS FOR A PARTICULAR PURPOSE. Hewlett-Packard shall not be liable for errors contained herein or for incidental or consequential damages in connection with the furnishing, performance or use of this material.

Hewlett-Packard assumes no responsibility for the use or reliability of its software on equipment that is not furnished by Hewlett-Packard.

This document contains proprietary information that is protected by copyright. All rights reserved. No part of this document may be photocopied, reproduced or translated to another language without the prior written consent of Hewlett-Packard Company.

RESTRICTED RIGHTS LEGEND. Use, duplication, or disclosure by government is subject to restrictions as set forth in subdivision (c) (1) (ii) of the Rights in Technical Data and Computer Software Clause at DFARS 252.227.7013. Hewlett-Packard Co., 3000 Hanover St., Palo Alto, CA 94304.

10 9 8 7 6 5 4 3 2 1

---

## Introduction

The A4979A PMC graphics card is designed to be used with the Model 744 single board computer (SBC) only. You may install up to four PMC graphics card in one system. HP-UX 10.20 ACE supports up to four graphics displays. If you have four PMC graphics cards in your system, and the Model 744 has onboard graphics, you must disable the onboard graphics (using the instructions provided here).

Use the instructions provided here along with *Installing the A4504A PMC Bridge Adapter and A4509A Expansion Adapter (A4504-90601)* (included with the adapters) and the *Owner's Guide* for your system

When you power on the system, or during operation through the use of the System Administration Manager (SAM), you can choose the correct resolution for your monitor. The maximum resolutions supported by this card are:

- 1280x1024 - 72 HZ - Double-buffered (monitor type 13), or
- 1600x1200 -75 HZ - 8-plane (monitor type 8)

For multiple display systems, please see HP's *Graphics Administration Guide* (B2355-90109).

---

## Kit Contents

Make sure that you have kit A4979A and that it contains the following items:

- PMC graphics card
- Mounting hardware
- Static strap

## Tools Required

---

### Tools Required

You'll need the following items to install the PMC graphics card:

- Small flat-tipped screwdriver.
  - Static-free work area.
- 

### Prerequisites

- 1 There is a minimum firmware revision level for the Model 744 board computers: a firmware upgrade is needed if the Boot ROM revision is **prior** to revision 4.0. To determine the revision level of the Boot ROM on your Model 744, type the command **IN FV** at the Boot Console Handler (BCH) Main Menu prompt (more details are available in your *Model 744 Owner's Guide*). You may obtain a firmware upgrade and instructions from your local Country Response Center (in North America you may call 800-633-3600) or through the WWW at:  
<http://us-support.external.hp.com> .
- 2 Your system must be running Workstation ACE (1998 06) for HP-UX 10.20 or later.
- 3 If you are connecting a monitor that does not have an EVC-style connector, you will need HP's A4168A adapter cable.
- 4 If you need to compute power usage for the PMC graphics card, the PMC graphics cards draw through the bridge adapter:
  - +5 Vdc - 2.33 A (typical)
  - +12 Vdc - 2.0 mA (typical)

---

**CAUTION:**

The internal components of your system are susceptible to mechanical and electrostatic shock. To prevent such damage from occurring, observe the following precautions during the installation procedure.

- Stand on a static-free mat
  - Wear a static-grounding wrist strap to ensure that any accumulated electrostatic charge discharges from your body to ground. Attach the static-grounding wrist strap by following the instructions on the package that contains the strap. Be sure to attach one end of the strap to the system chassis.
  - Handle system and upgrade kit components carefully to prevent damage from mechanical shock.
-

## Procedure

---

### Procedure

---

**NOTE:**

---

If you need to update your **Model 744** board computer's firmware or operating system as instructed in **Prerequisites**, update now before completing the procedure.

---

**NOTE:**

---

If you are installing four PMC cards onto a Model 744 that has onboard graphics, you will need to disable the onboard graphics (directions are later in the procedure). You will also need to redirect the console path before shutting off the system:

- i** Reboot the system.
- ii** If **Autoboot** is turned on, press any key when you see the following message:

Processor is starting Autoboot process. To discontinue, press any key within 10 seconds.

- iii** Use the following command at the Main Menu prompt to configure the console path for a PMC graphics card:

**pa con pmcn**

where **n** is the PMC card site number.

- 1 If this PMC card is being installed in a system that is already in use, before shutting down the operating system, log in as **superuser** or **root** and enter the following command in a terminal window:

```
rm /dev/crt*
```

- 2 Stop any application programs, then shut down your system.
- 3 Turn the system off, and unplug the power cord(s) and all other cables to the SBC.

---

**WARNING:**

---

**To avoid electrical shock, make sure you unplug the power cable from the wall outlet and the system unit before proceeding any further.**

- 4 Using a flat-tipped screwdriver, unscrew the captive screws that secure the board computer in the card cage.
- 5 Use the ejector handles to eject the board, and pull the board computer assembly out of the card cage.
- 6 Decide which PMC site you will install the card into, and remove the PMC bridge and expansion adapter (if present) from the Model 744 SBC.
- 7 On the PMC bridge adapter or expansion board, at the site where you will be installing the PMC card, remove the two screws that secure the bezel blank, and remove the blank. See Figure 1 and Figure 2.

---

**NOTE:**

---

When installing a PMC card, ensure that the O-ring type gasket near the bezel remains in place.

- 8 Install the PMC card onto the adapter by aligning the front of the card with the front bezel, and the rear of the card with the connectors and keying pin. See Figure 1 or Figure 2. There are four screws that secure the PMC card from the bottom of the adapter (use the screws included with the kit).

## Procedure

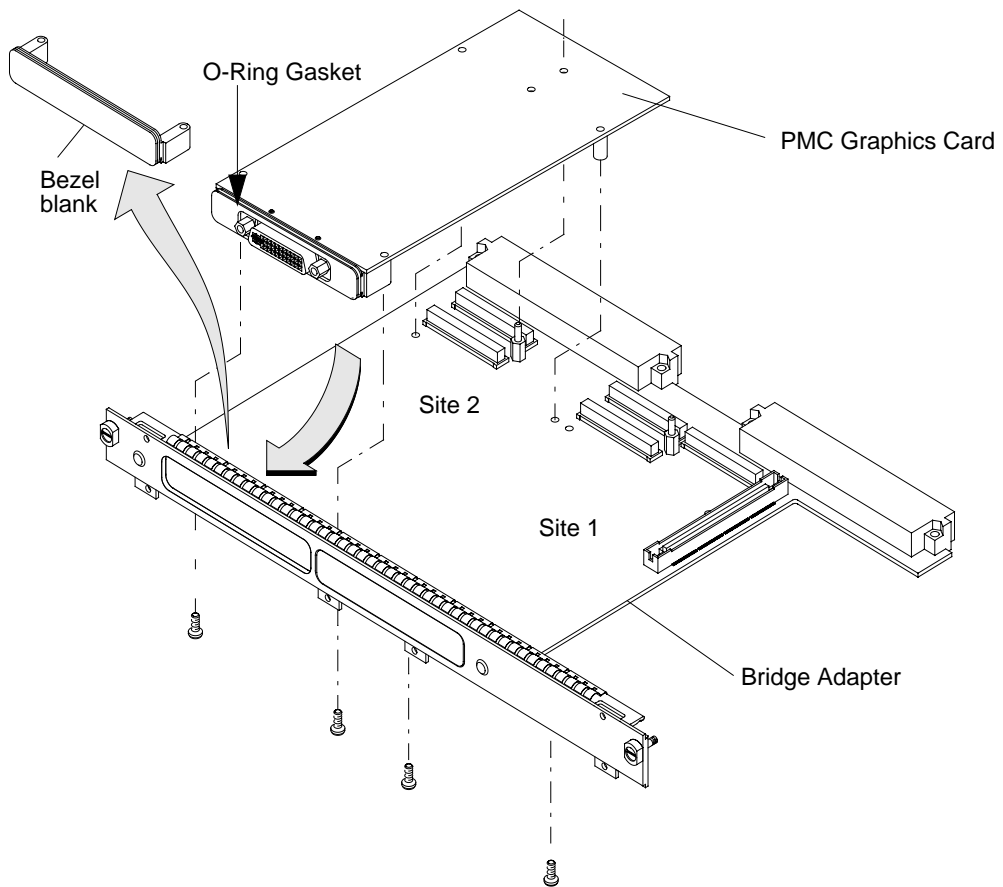
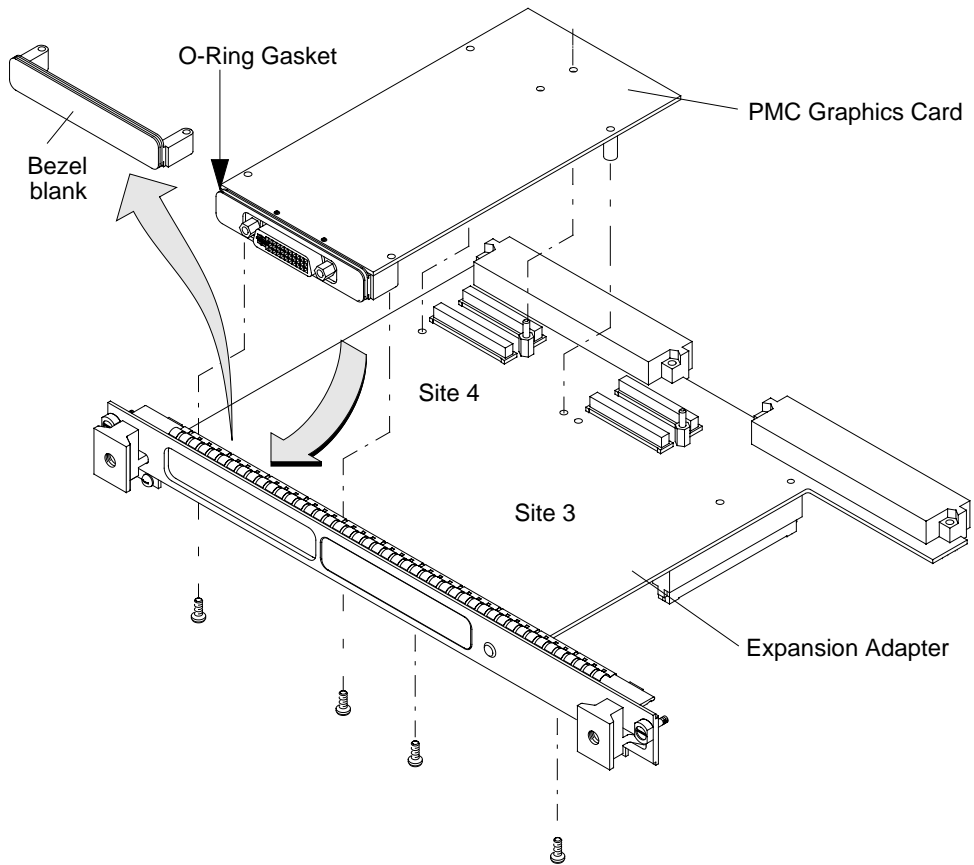

Figure 1

Installing a PMC Card onto the Bridge Adapter



**Figure 2**                      **Installing a PMC Card onto the Expansion Adapter**

## Procedure

- 9 If you are using both the PMC bridge and expansion adapters, connect them together, making sure that the connector and bezels are properly aligned, as shown in Figure 3. Ensure that the interboard connector seats properly by applying pressure to the top of the expansion board and to the bottom of the bridge board at the interboard connector. There are two screws that secure the front bezel and four screws to secure the backplane connectors.

---

**NOTE:**

If the interboard connector is not tightly seated, PMC cards on the expansion adapter will not operate.

---

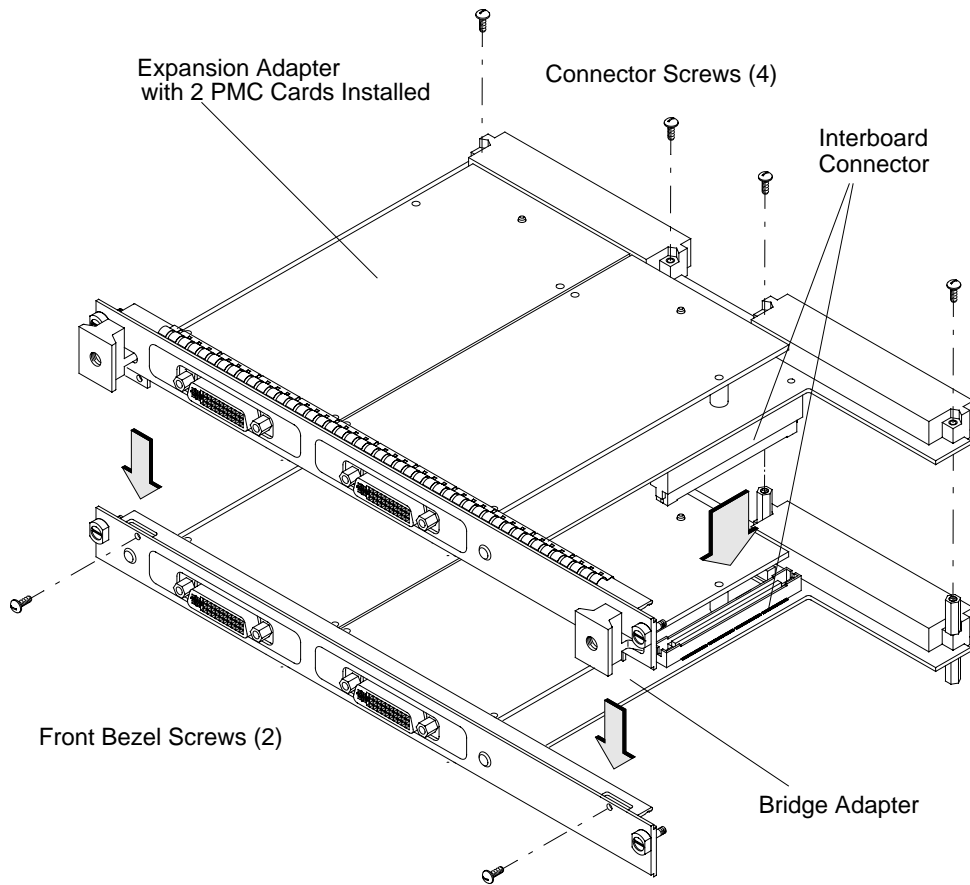
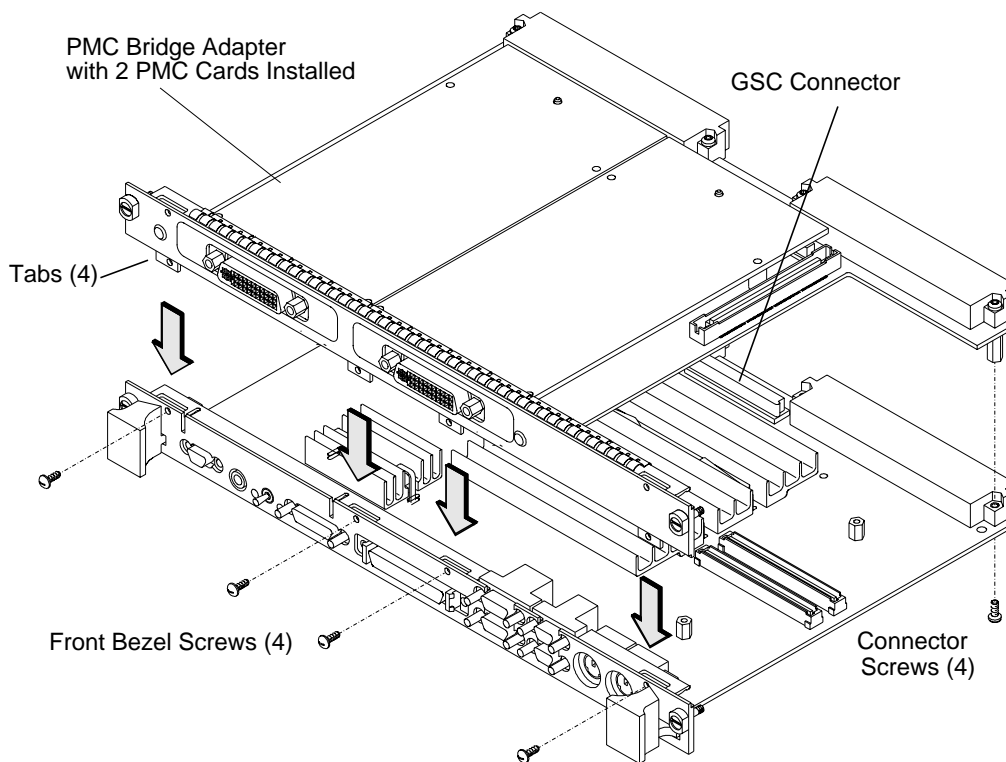

Figure 3

Installing the Expansion Adapter onto the Bridge Adapter

- 10 Install the PMC bridge adapter (as shown in Figure 4) or the bridge adapter with expansion adapter (as shown in Figure 5) onto the SBC. Align the GSC connector first, then the tabs on the front panel, and push the boards together. There are four screws that secure the front bezel, and four screws that secure the backplane connectors.



**Figure 4** Installing the PMC Bridge Adapter onto the SBC

## Procedure

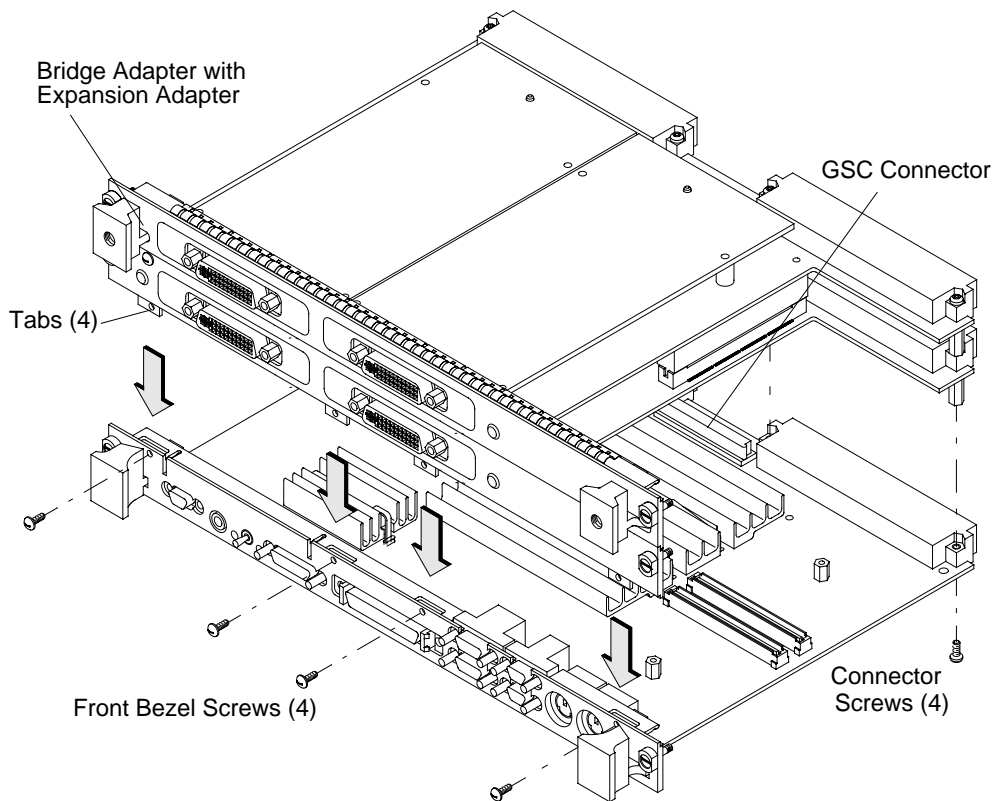

**Figure 5**                      **Installing the Bridge Adapter with the Expansion Adapter onto the SBC**

---

**CAUTION:**

---

When installing the board computer and PMC adapter(s) into a Model 748 industrial system, to properly seat the assembly in the card cage you must push down slightly on the assembly for the last 2.5 cm (one inch) of travel in order to compress the EMI gasket on the card cage.

- 11** Insert the board computer with the attached PMC adapter(s) into the card cage slots until the assembly seats properly and the front panels are flush against the card cage.

---

**CAUTION:** Do not tighten any captive screws until each captive screw has been started to be threaded into its hole.

---

**12** Engage all captive screws before tightening each screw of the board computer and PMC adapter(s). See Figure 6.

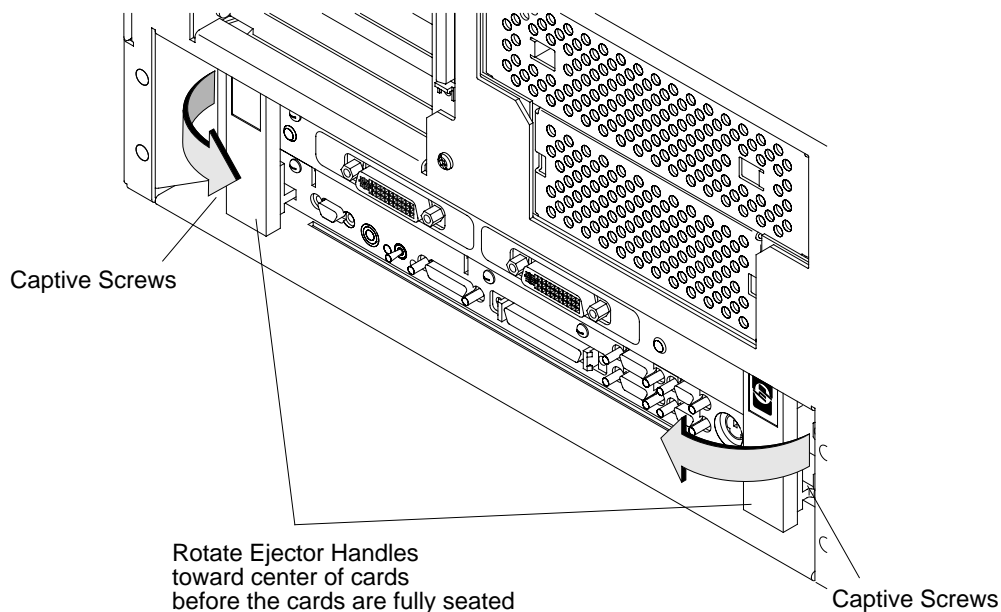

**Figure 6** **Installing the Board Computer with PMC into Card Cage**

**13** Connect the monitor cables to the PMC graphics card and all other cables to the SBC and card cage.

**14** Plug in the power cord(s), and then turn on the power for the card cage.

**15** If **Autoboot** is turned on, press any key when you see the following message:

Processor is starting Autoboot process. To discontinue, press any key within 10 seconds.

## Procedure

- 16** Use the following command at the Main Menu prompt to configure the monitor for your PMC graphics card:

```
co mo pmcn tt
```

where *n* is the PMC card site number, and *tt* is the monitor type number.

- 17** You can use the following command to get a full list of the valid monitor types:

```
co mo list
```

- 18** If you have onboard graphics and have installed four PMC graphics cards, you must disable the Model 744 onboard graphics with the command:

```
co mo disable builtin
```

---

**NOTE:**

---

If you disable the onboard graphics, and later need to use the onboard graphics as the console device, use the procedure in your system's *Owner's Guide* for the "Using the Emergency Interactive Console Search" feature.

- 19** After configuring the monitor, continue the boot process by using the following command at the Main Menu prompt:

```
boot
```

- 20** If you choose to use the online Support Tools Manager (xstm) to verify operation of more than two PMC graphics cards in your system, you need to change two parameters within the System Administration Manager (SAM):
- Within SAM, select **Kernel Configuration**
  - Then select **Configurable Parameters**
  - Change the following two parameters:  
semmni = 128  
semmns = 256
  - When exiting SAM, create a New Kernel with the new configuration.
  - Choose to move the Kernel into place and allow SAM to shutdown/reboot the system.



## Procedure

Part Number A4979-90602  
Printed in U.S.A.  
Edition E1098

